

REDONDOS

Vidrio 6 a 12 mm

TIRADOR DOBLE Ø 15 mm

Acabados:

AISI-316 L

C.C. = 130 L = 170

Inox brillo	4299 IB
Inox mate	4299 IM

AISI-304

C.C. = 130 L = 170

Inox brillo	4299.10 IB
Inox mate	4299.10 IM

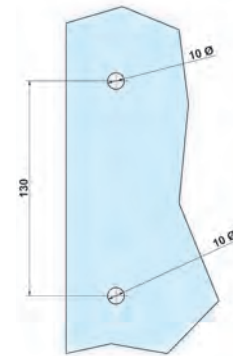

T2017 A316L
T2017 A304
T2017S A316L
T2017S A304

TIRADOR SIMPLE Ø 15 mm

Acabados:

AISI-316 L

C.C. = 130 L = 170

Inox brillo	4299.1 IB
Inox mate	4299.1 IM

AISI-304

C.C. = 130 L = 170

Inox brillo	4299.11 IB
Inox mate	4299.11 IM

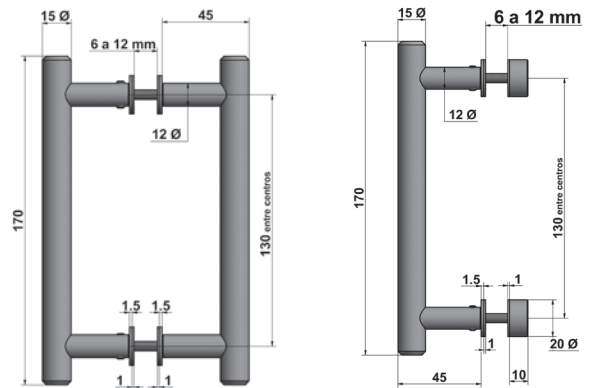

TIRADOR DOBLE Ø 30 mm

AISI-304

Acabados:

C.C. = 200 L = 400

Inox brillo	4296.5 IB
Inox mate	4296.5 IM

C.C. = 250 L = 500

Inox brillo	4297.5 IB
Inox mate	4297.5 IM

C.C. = 300 L = 600

Inox brillo	4298.5 IB
Inox mate	4298.5 IM



T4730
T4730 -S

TIRADOR SIMPLE Ø 30 mm

AISI-304

Acabados:

C.C. = 200 L = 400

Inox brillo	4296.6 IB
Inox mate	4296.6 IM

C.C. = 250 - 500

Inox brillo	4297.6 IB
Inox mate	4297.6 IM

C.C. = 300 - 600

Inox brillo	4298.6 IB
Inox mate	4298.6 IM

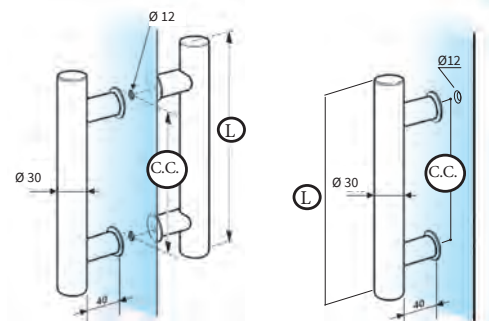

C.C.	L
200	400
250	500
300	600

C.C.	L
200	400
250	500
300	600

* Opción pared bajo pedido

TIRADOR DOBLE Ø 30 mm

T4757
T4757 - S

Acabados:

L = 200

Plata brillo	4296 PB
Plata mate veloux	4296 PM
Metacrilato plata brillo	4296 MPB
Metacrilato plata mate	4296 MPM

L = 250

Plata brillo	4297 PB
Plata mate veloux	4297 PM
Metacrilato plata brillo	4297 MPB
Metacrilato plata mate	4297 MPM

L = 300

Plata brillo	4298 PB
Plata mate veloux	4298 PM
Metacrilato plata brillo	4298 MPB
Metacrilato plata mate	4298 MPM



TIRADOR SIMPLE Ø 30 mm

Acabados:

L = 200

Plata brillo	4296.1 PB
Plata mate veloux	4296.1 PM
Metacrilato plata brillo	4296.1 MPB
Metacrilato plata mate	4296.1 MPM

L = 250

Plata brillo	4297.1 PB
Plata mate veloux	4297.1 PM
Metacrilato plata brillo	4297.1 MPB
Metacrilato plata mate	4297.1 MPM

L = 300

Plata brillo	4298.1 PB
Plata mate veloux	4298.1 PM
Metacrilato plata brillo	4298.1 MPB
Metacrilato plata mate	4298.1 MPM

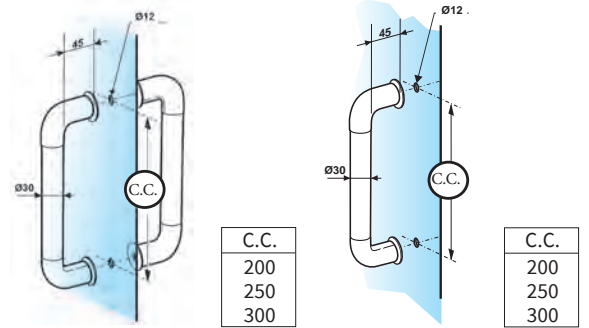

TIRADOR PARED BAÑO Ø 30 mm

T4757 - A

Acabados:

L = 200

Plata brillo	4296.2 PB
Plata mate veloux	4296.2 PM

L = 250

Plata brillo	4297.2 PB
Plata mate veloux	4297.2 PM

L = 300

Plata brillo	4298.2 PB
Plata mate veloux	4298.2 PM

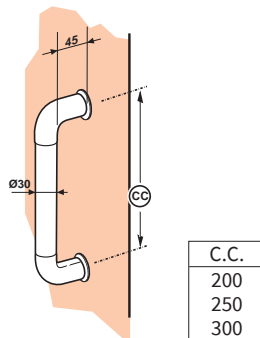

TIRADOR BAÑO Ø 30 mm

T4790

Vidrio 8 a 12 mm

Acabados:

C.C. = 300 L = 400

Plata brillo	4298.7 PB
Plata mate veloux	4298.7 PM

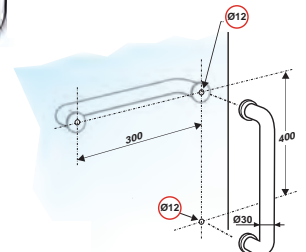

6.1 - TIRADORES

POMOS Y TIRADORES

TIRADORES | REDONDOS

Vidrio 6 a 12 mm

TIRADOR DOBLE Ø 40 mm

Acabados:

C.C. = 200 L = 300

Inox brillo	4296.3 IB
Inox mate	4296.3 IM
Madera cerezo ix.b.	4296.3 MCIB
Madera cerezo ix.m.	4296.3 MCIM
Madera roble ix.b.	4296.3 MRIB
Madera roble ix.m.	4296.3 MRIM
Metacrilato ix.b.	4296.3 MIB
Metacrilato ix.m.	4296.3 MIM

C.C. = 250 L = 400

Inox brillo	4297.3 IB
Inox mate	4297.3 IM
Madera cerezo ix.b.	4297.3 MCIB
Madera cerezo ix.m.	4297.3 MCIM
Madera roble ix.b.	4297.3 MRIB
Madera roble ix.m.	4297.3 MRIM
Metacrilato ix.b.	4297.3 MIB
Metacrilato ix.m.	4297.3 MIM

C.C. = 300 L = 500 mm

Inox brillo	4298.3 IB
Inox mate	4298.3 IM
Madera cerezo ix.b.	4298.3 MCIB
Madera cerezo ix.m.	4298.3 MCIM
Madera roble ix.b.	4298.3 MRIB
Madera roble ix.m.	4298.3 MRIM
Metacrilato ix.b.	4298.3 MIB
Metacrilato ix.m.	4298.3 MIM



- T4758
- T4770
- T4769
- T4759
- T4758S
- T4770S
- T4769S
- T4759S

TIRADOR SIMPLE Ø 40 mm

Acabados:

C.C. = 200 L = 300

Inox brillo	4296.4 IB
Inox mate	4296.4 IM
Madera cerezo ix.b.	4296.4 MCIB
Madera cerezo ix.m.	4296.4 MCIM
Madera roble ix.b.	4296.4 MRIB
Madera roble ix.m.	4296.4 MRIM
Metacrilato ix.b.	4296.4 MIB
Metacrilato ix.m.	4296.4 MIM

C.C. = 250 L = 400

Inox brillo	4297.4 IB
Inox mate	4297.4 IM
Madera cerezo ix.b.	4297.4 MCIB
Madera cerezo ix.m.	4297.4 MCIM
Madera roble ix.b.	4297.4 MRIB
Madera roble ix.m.	4297.4 MRIM
Metacrilato ix.b.	4297.4 MIB
Metacrilato ix.m.	4297.4 MIM

C.C. = 300 L = 500

Inox brillo	4298.4 IB
Inox mate	4298.4 IM
Madera cerezo ix.b.	4298.4 MCIB
Madera cerezo ix.m.	4298.4 MCIM
Madera roble ix.b.	4298.4 MRIB
Madera roble ix.m.	4298.4 MRIM
Metacrilato ix.b.	4298.4 MIB
Metacrilato ix.m.	4298.4 MIM

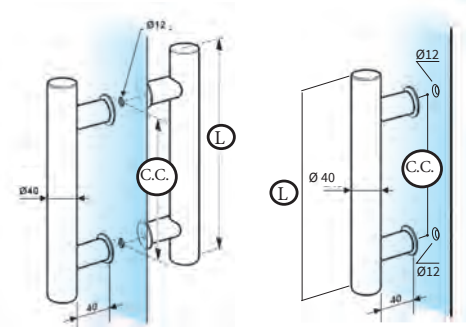

* Opción pared bajo pedido

C.C.	L
200	300
250	400
300	500

C.C.	L
200	300
250	400
300	500

INOX CUADRADOS

TIRADOR \square 20 mm
C.C. = 200 L = 220

T4762
T4762S

Acabados:

DOBLE

Inox brillo	4285.10 IB
Inox mate	4285.10 IM

SIMPLE

4285.1

C.C. = 250 L = 270

Acabados:

DOBLE

Inox brillo	4285.20 IB
Inox mate	4285.20 IM

SIMPLE

4285.3

C.C. = 300 L = 320

Acabados:

DOBLE

Inox brillo	4285.40 IB
Inox mate	4285.40 IM

SIMPLE

4285.5

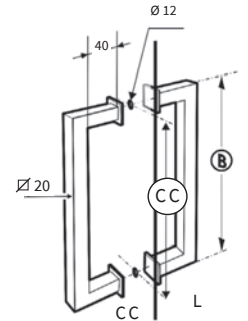

C.C.	L
200	220
250	270
300	320

TIRADOR \square 20 mm
C.C. = 200 L = 350

T4764
T4764S

Acabados:

DOBLE

Inox brillo	4287.10 IB
Inox mate	4287.10 IM

SIMPLE

4287.1

C.C. = 250 L = 400

Acabados:

DOBLE

Inox brillo	4287.20 IB
Inox mate	4287.20 IM

SIMPLE

4287.3

C.C. = 300 L = 450

Acabados:

DOBLE

Inox brillo	4287.40 IB
Inox mate	4287.40 IM

SIMPLE

4287.5

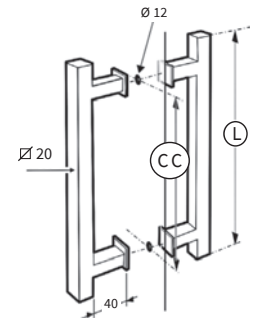

C.C.	L
200	350
250	400
300	450

INOX REGULABLES REDONDOS

Vidrio 6 a 12 mm

TIRADOR Ø 10 mm

L = 400

Acabados:

DOBLE

Inox brillo	4296.8 IB
Inox mate	4296.8 IM

SIMPLE

4296.9

L = 500

Acabados:

DOBLE

Inox brillo	4297.8 IB
Inox mate	4297.8 IM

SIMPLE

4297.9

L = 600

DOBLE

Inox brillo	4298.8 IB
Inox mate	4298.8 IM

SIMPLE

4298.9



T4761
T4761S

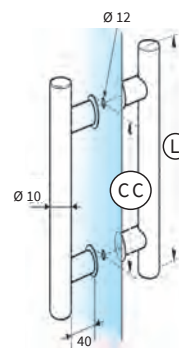

C.C.	L
Reg	400
Reg	500
Reg	600

TIRADOR DOBLE Ø 20 mm

L = 500

Acabados:

Inox mate	4282 IM
-----------	----------------



T4760

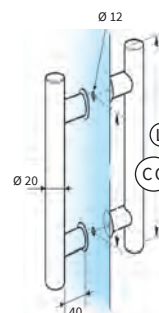

C.C.	L
Reg	500

TIRADOR Ø 20 mm

L = 1200

Acabados:

DOBLE

Inox brillo	4284 IB
Inox mate	4284 IM

SIMPLE

Inox brillo	4284.1 IB
Inox mate	4284.1 IM

TIRADOR Ø 30 mm

L = 1200

Acabados:

DOBLE

Inox brillo	4283 IB
Inox mate	4283 IM

SIMPLE

Inox brillo	4283.1 IB
Inox mate	4283.1 IM

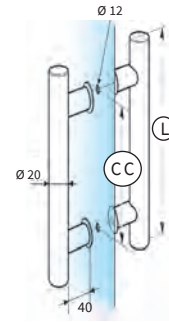

C.C.	L
Reg	1200

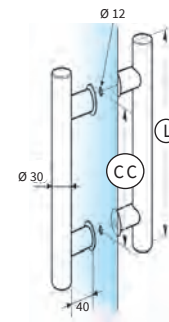

C.C.	L
Reg	1200

T4767
T4767S
T4765
T4765S

INOX REGULABLES CUADRADOS

Vidrio 6 a 12 mm

TIRADOR ∅ 20 mm

L = 1200

Acabados:

DOBLE

Inox brillo	4289 IB
Inox mate	4289 IM

SIMPLE

Inox brillo	4289.1 IB
Inox mate	4289.1 IM

TIRADOR ∅ 30 mm

L = 1200

Acabados:

DOBLE

Inox brillo	4288 IB
Inox mate	4288 IM

SIMPLE

Inox brillo	4288.1 IB
Inox mate	4288.1 IM

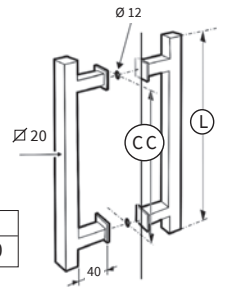

C.C.	L
Reg	1200

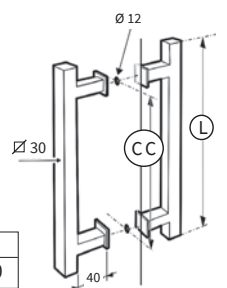

C.C.	L
Reg	1200

T4768
T4768S
T4766
T4766S